

PER 1900

Série Robusta p/ Portões com Bite

PERFACE
ALUMÍNIOS VALE DO SOUSA, LDA.

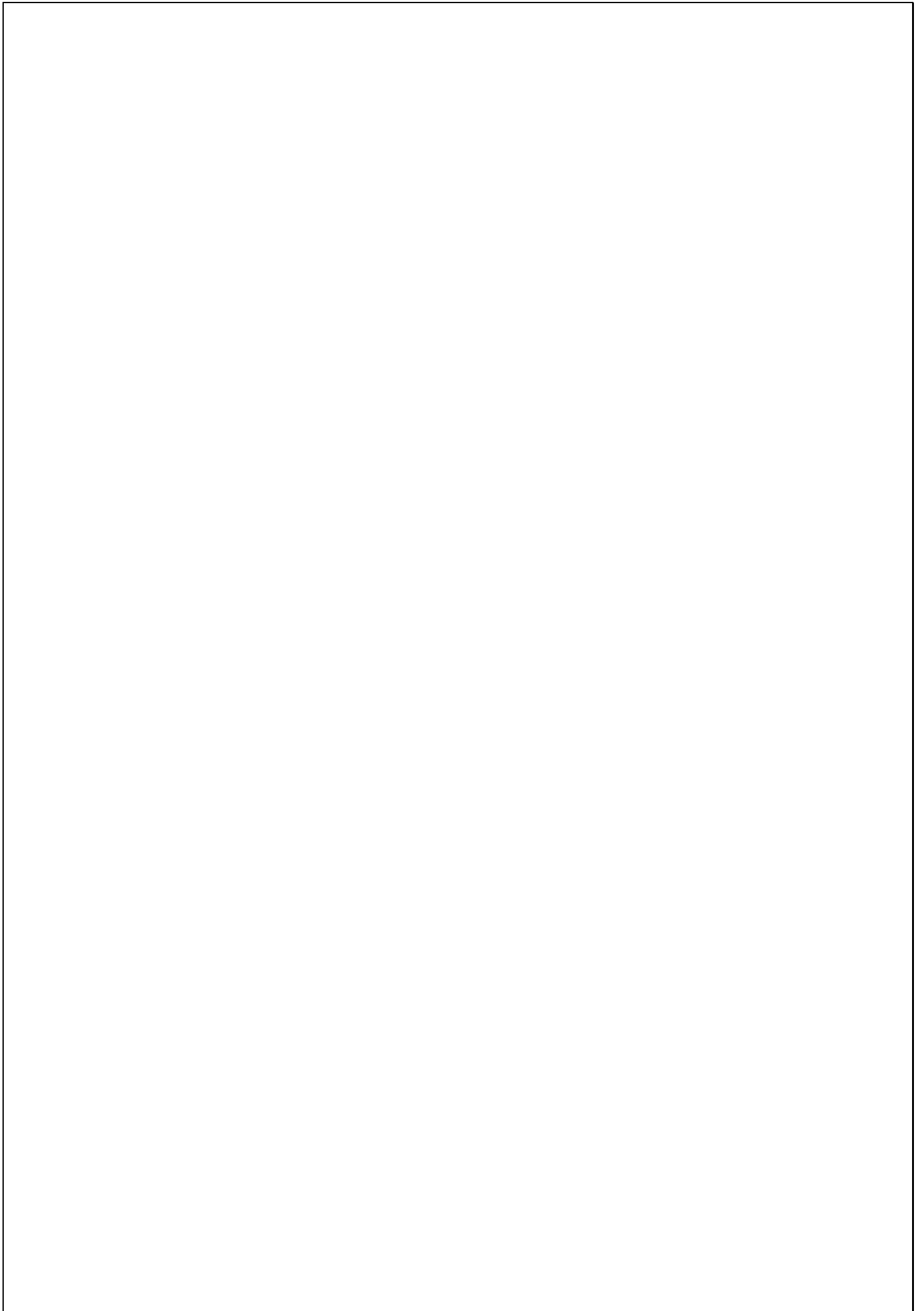



LISTA DE PERFIS

| Perfil | Designação | Referência | Perfil | Designação | Referência |
|--------|-------------------|------------|--------|------------|------------|
| | Aro Fixo | PER 1917 | | Bite | TE 2100 |
| | Remate de Batente | PER 1918 | | Bite | TE 2109 |
| | Aro Móvel | PER 1919 | | Bite | TE 2112 |
| | Travessa | PER 1920 | | Bite | TE 2113 |
| | Bite | TE 2013 | | Bite | TE 2114 |
| | Bite | TE 2045 | | Bite | TE 2114 C |
| | Bite | TE 2014 | | Bite | TE 2115 |
| | Bite | TE 2015 | | Bite | TE 2116 |
| | Bite | TE 2016 | | Bite | TE 2116 C |
| | Bite | TE 2017 | | Bite | TE 2143 |
| | Bite | TE 2018 | | Bite | TE 2217 |
| | Bite | TE 2019 | | Travessa | PER 4037 |
| | Travessa Pequena | PER 4038 | | Prumo | PER 4042 |

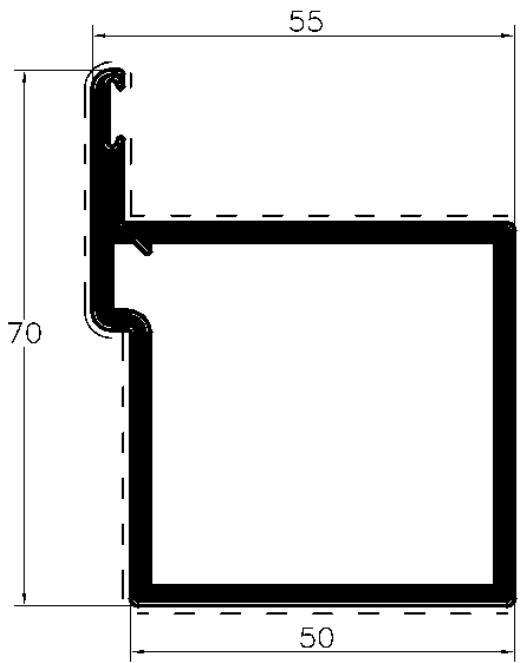

PER 1917

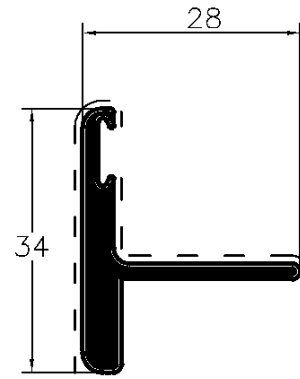

PER 1918

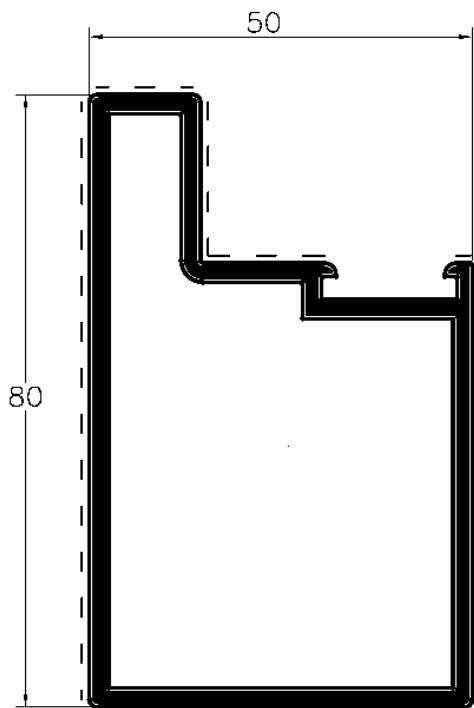

PER 1919

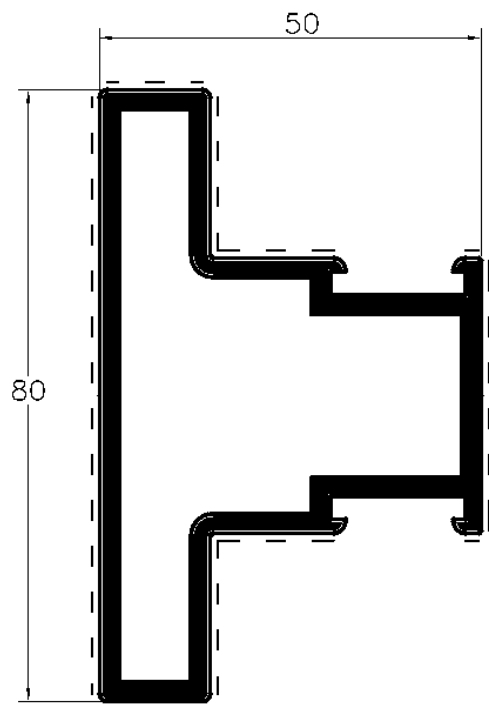

PER 1920

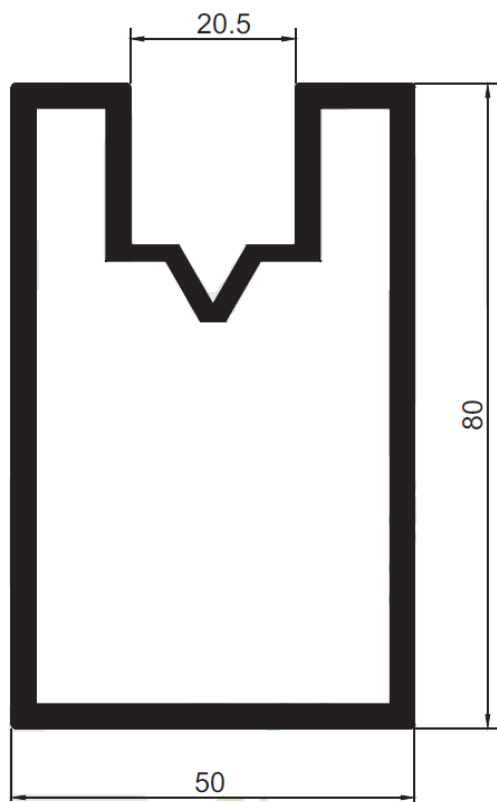

PER 4037

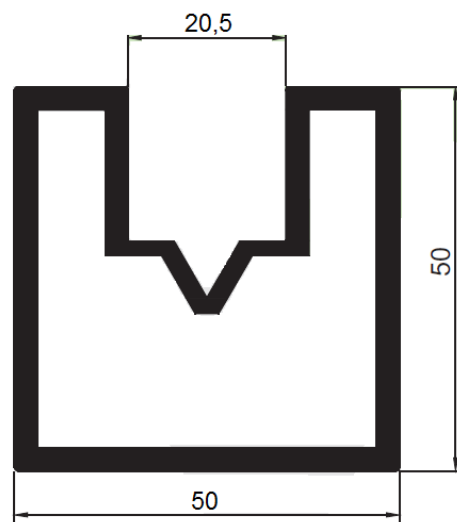

PER 4038

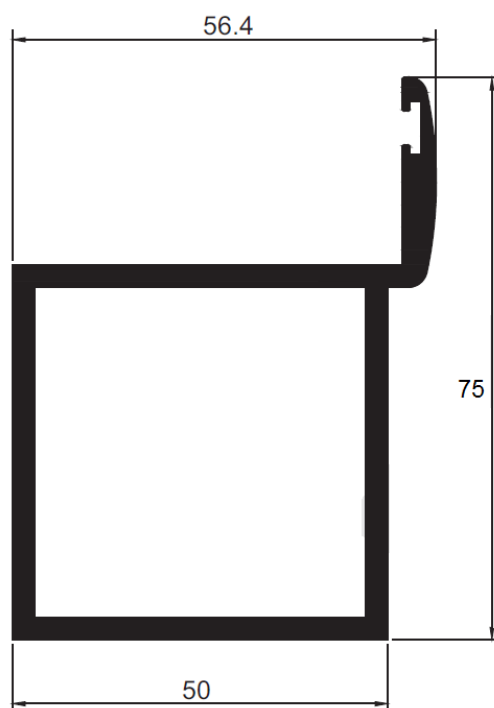

PER 4042



BITES

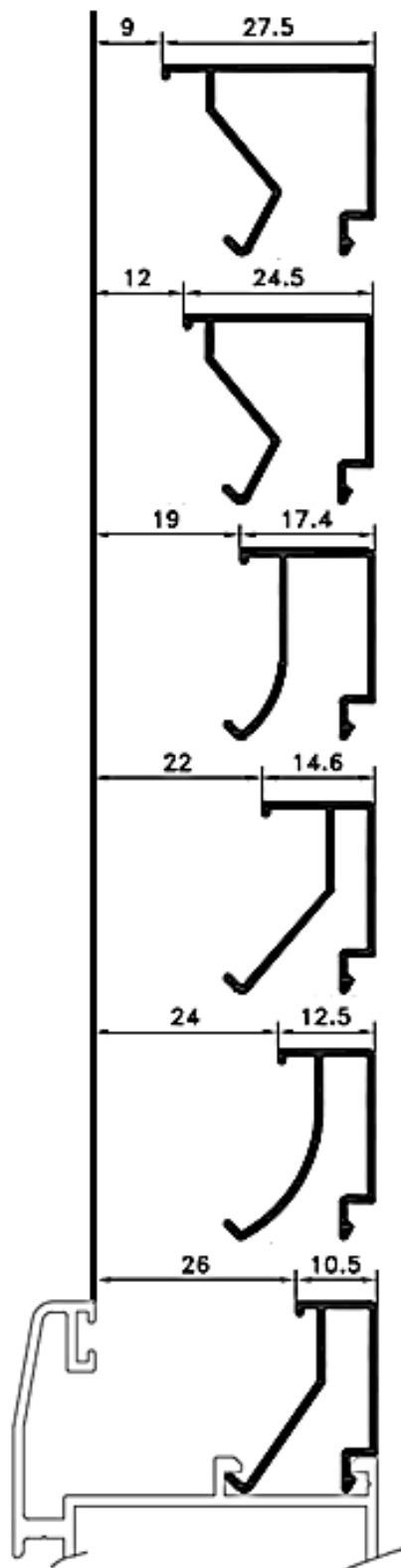

TE 2017

TE 2016

TE 2019

TE 2015

TE 2018

TE 2014

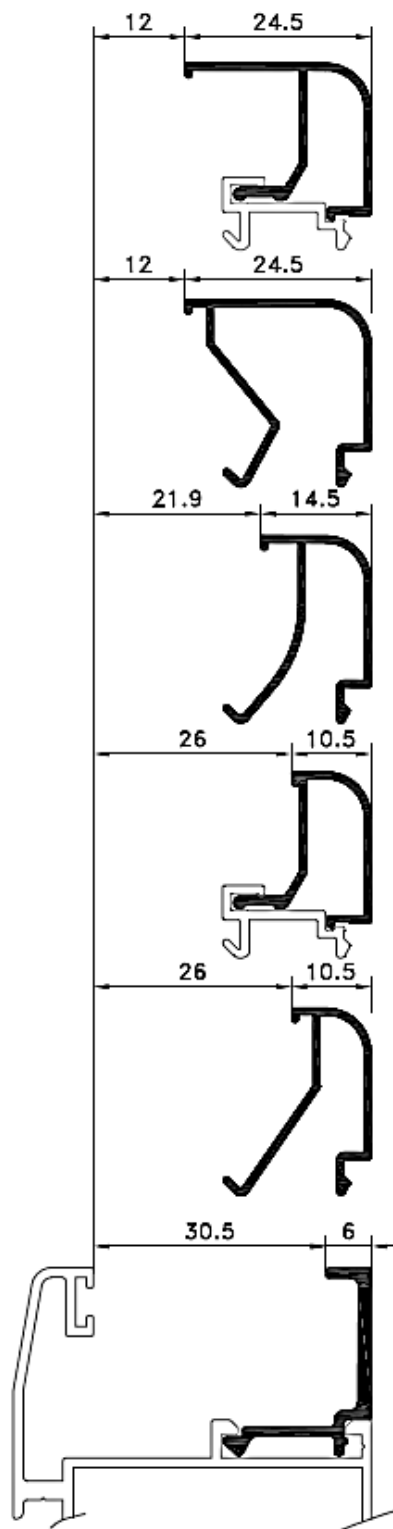

TE 2116 C
+ 2100 C

TE 2116

TE 2115

TE 2114 C
+ 2100 C

TE 2114

TE 2045



BITES

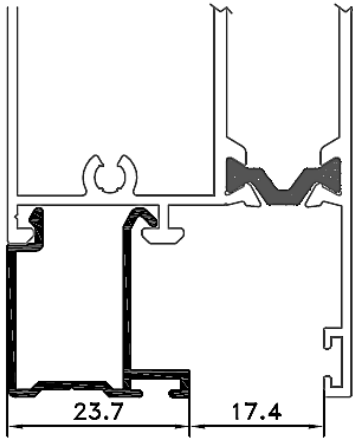

TE 2013

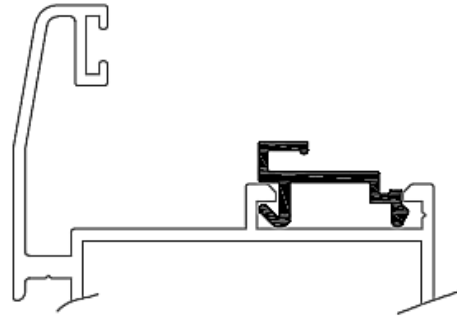

TE 2100

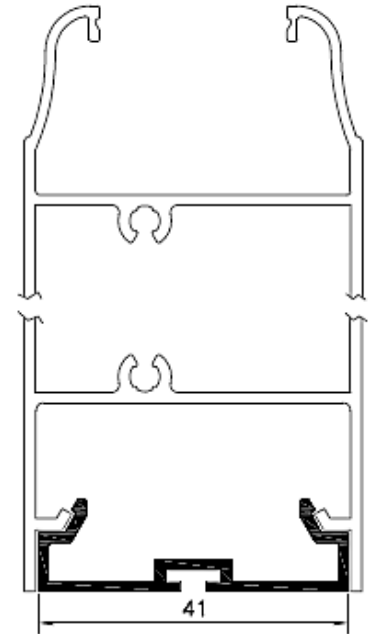

TE 2109

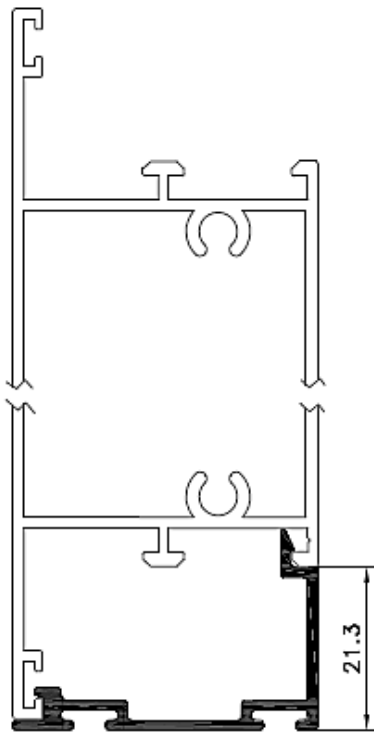

TE 2112

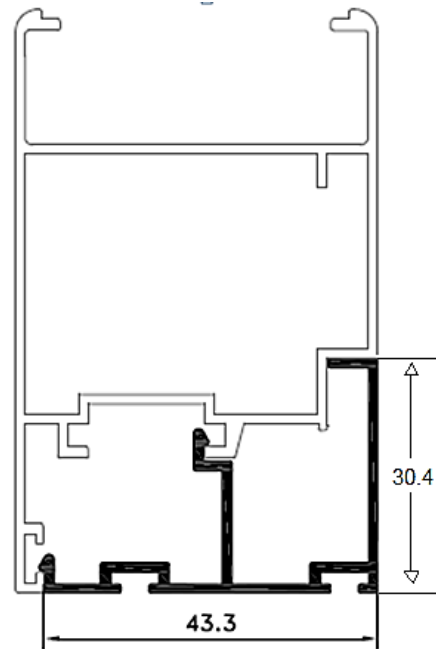

TE 2113



BITES

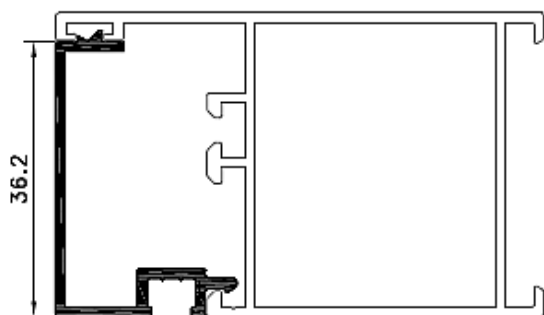

TE 2143

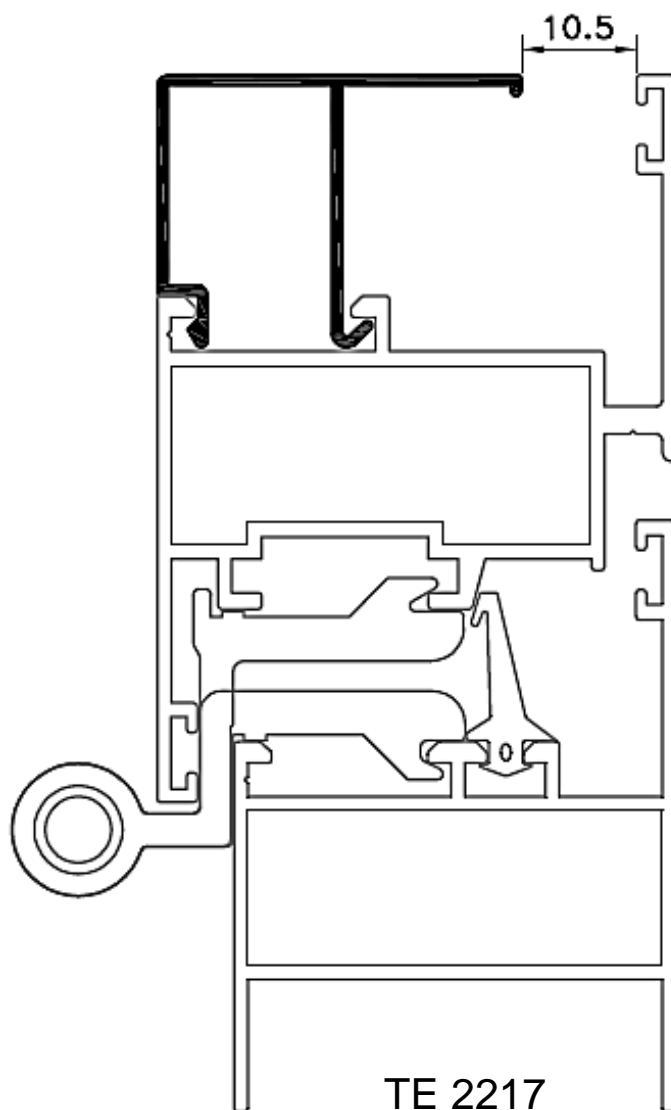

TE 2217