

TFA

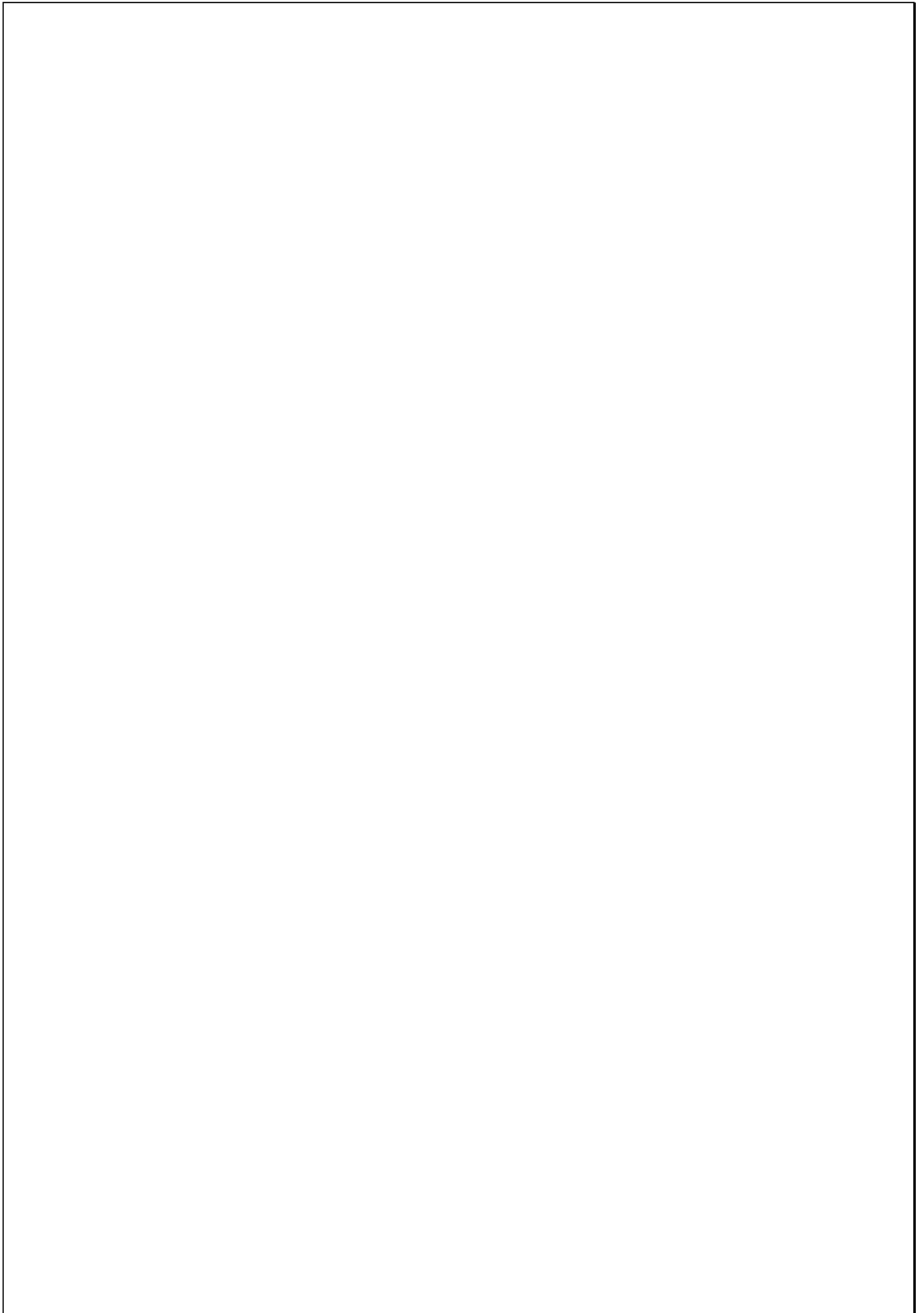









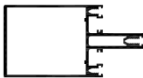

Série de Fachadas

PERFACE
ALUMÍNIOS VALE DO SOUSA, LDA.



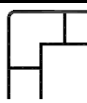

LISTA DE PERFIS

| Perfil | Designação | Referência |
|---|-----------------------------|------------|
|  | Prumo | TFA 01 |
|  | Travessa | TFA 02 |
|  | Perfil p/ Fixação de Vidro | TFA 03 |
|  | Capa p/ Prumo | TFA 04 |
|  | Capa p/ Travessa | TFA 05 |
|  | Bite p/ Vidro Simples | TFA 06 |
|  | Perfil p/ Semi-Estrutural | TFA 07 |
|  | Perfil de Fixação p/ TFA 07 | TFA 08 |
|  | Perfil de Fixação | TFA 08 A |
|  | Perfil de Fixação | TFA 08 B |
|  | Perfil de Fixação p/ Prumos | TFA 09 |
|  | Perfil p/ Canto | TFA 10 |
|  | Travessa | TFA 11 |
|  | Remate p/ Semi-Estrutural | TFA 12 |

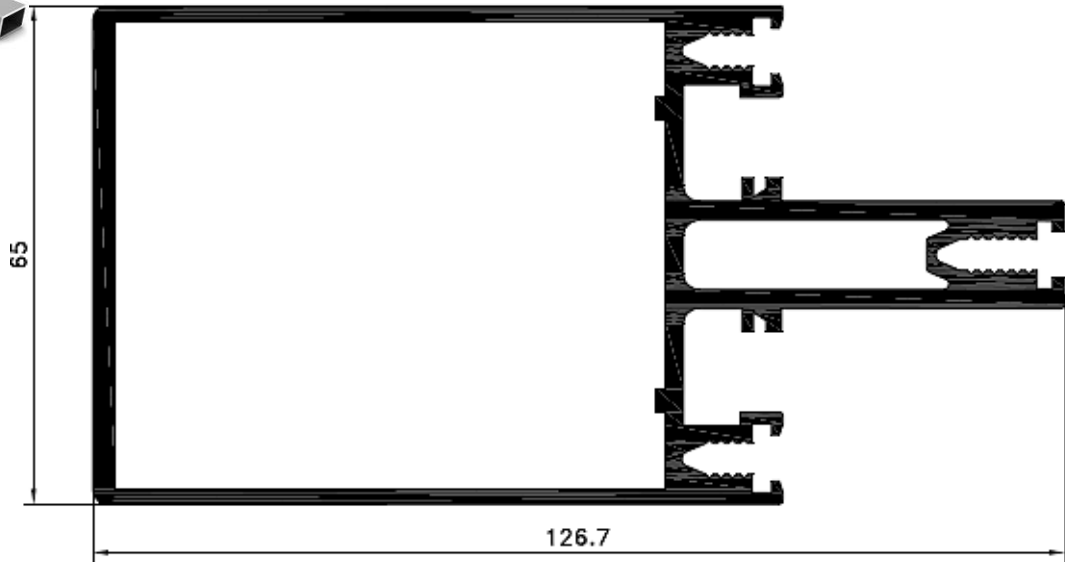

TFA 01

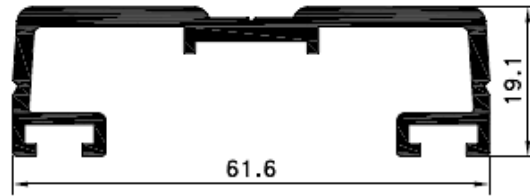

TFA 03

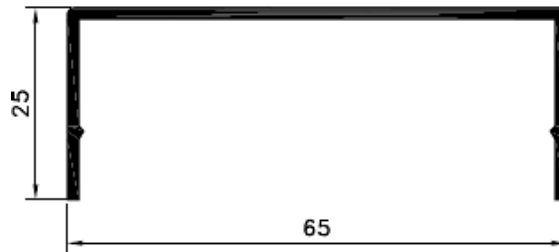

TFA 04

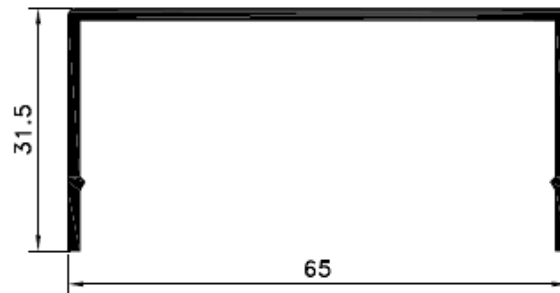

TFA 05

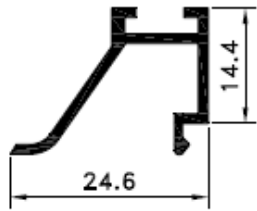

TFA 06

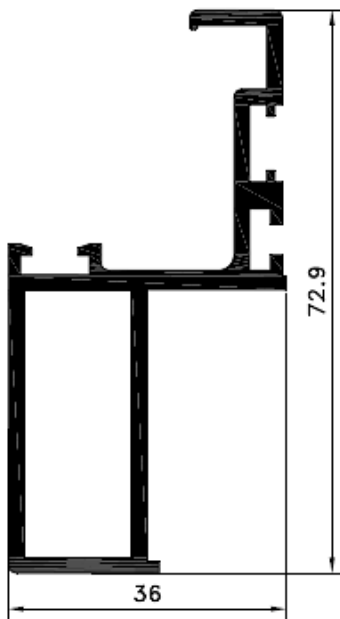
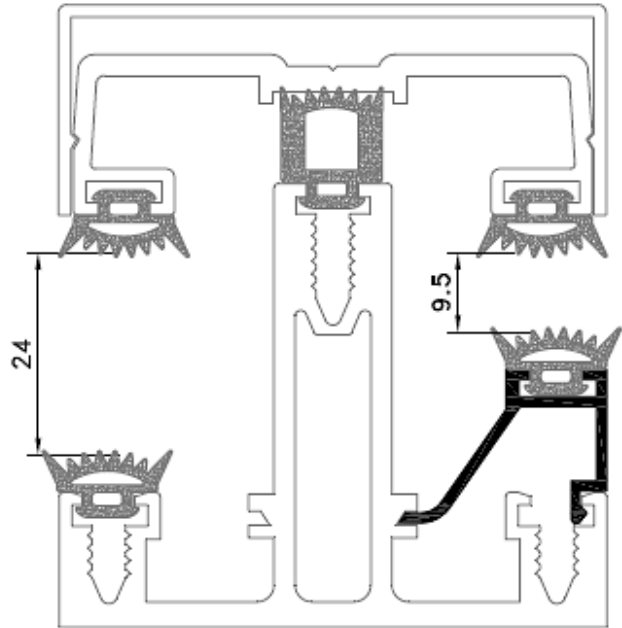

TFA 07

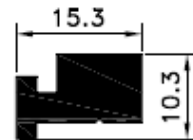

TFA 08

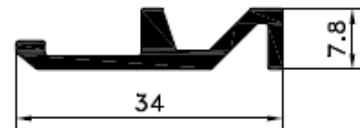

TFA 08 A

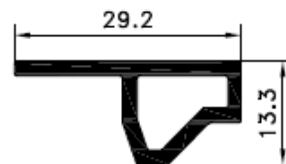

TFA 08 B

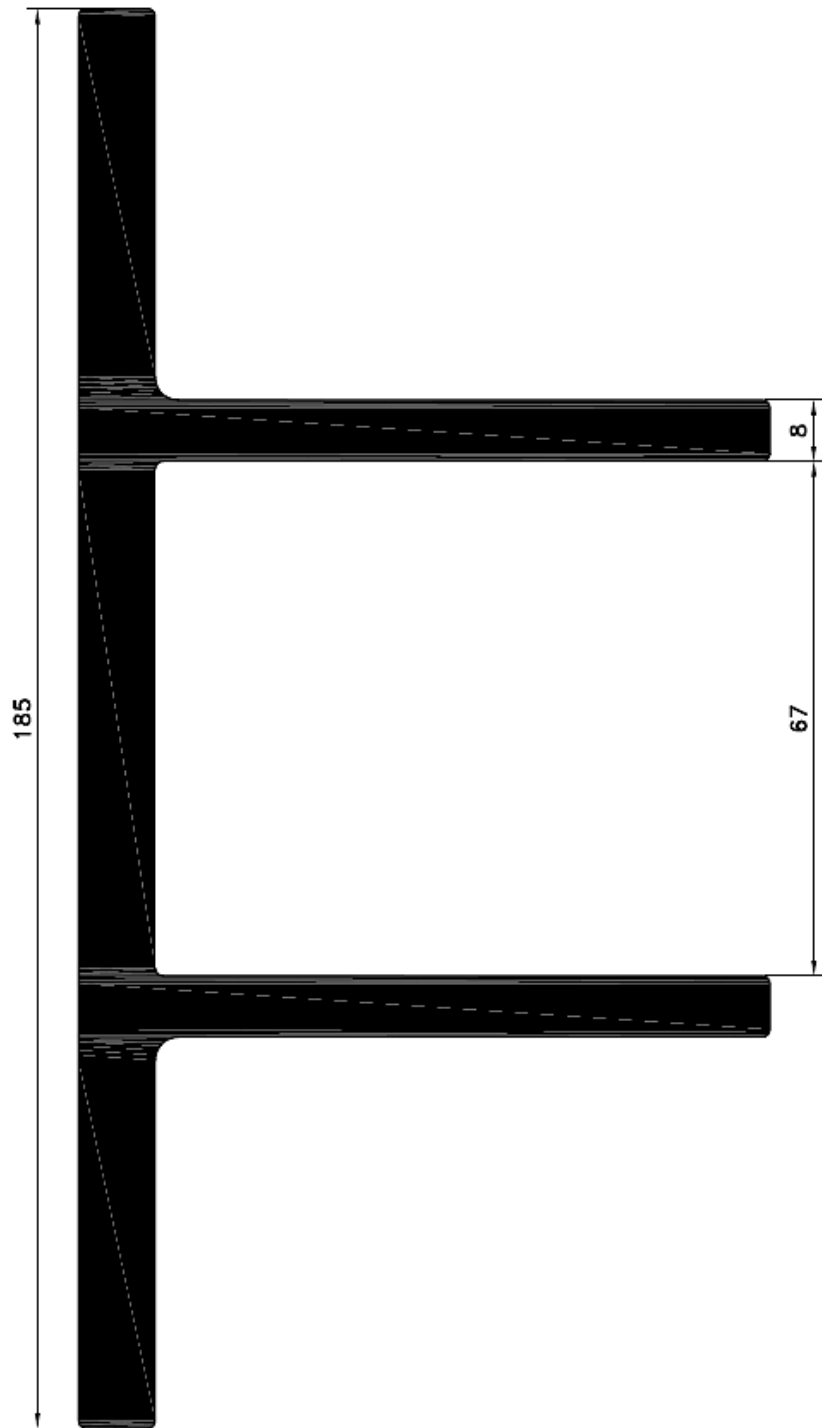

TFA 09

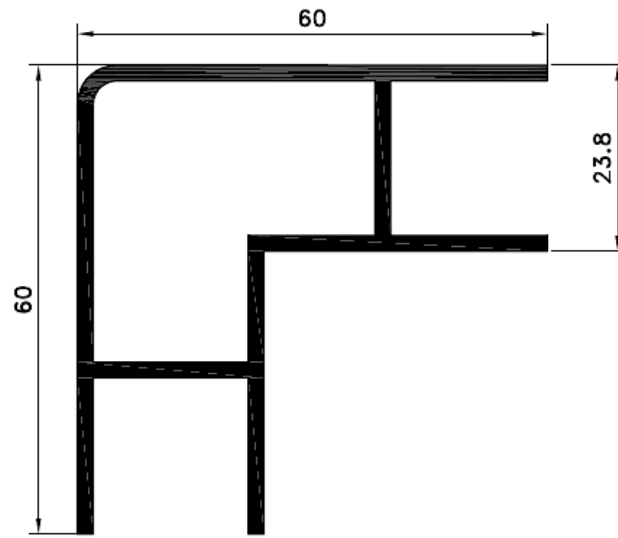

TFA 10

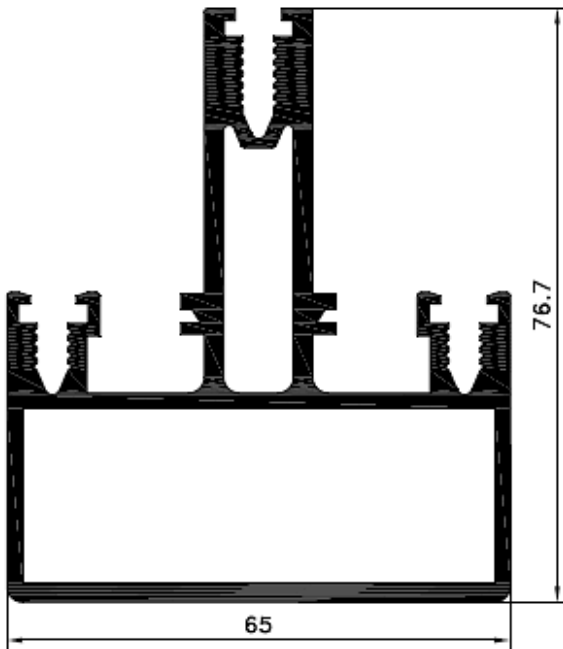

TFA 02

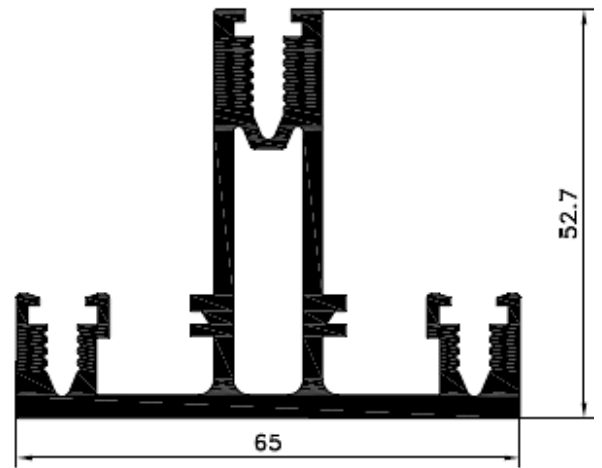

TFA 11

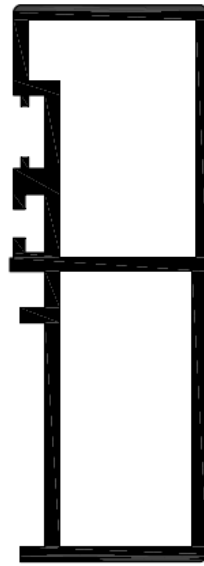

TFA 12

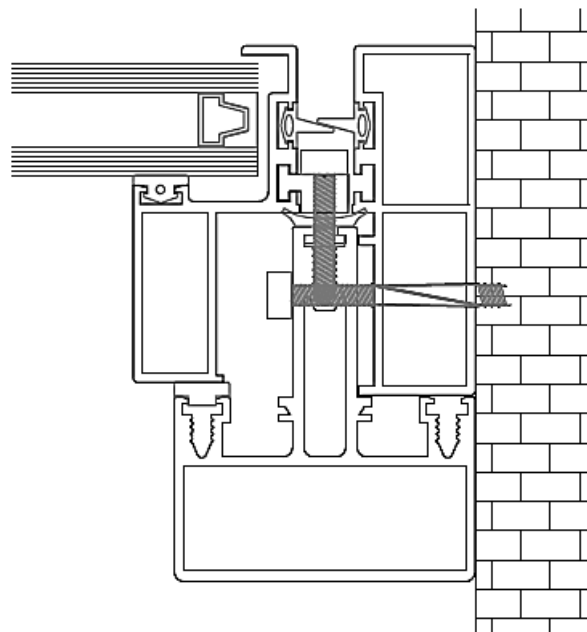

MONTAGEM DAS TRAVESSAS

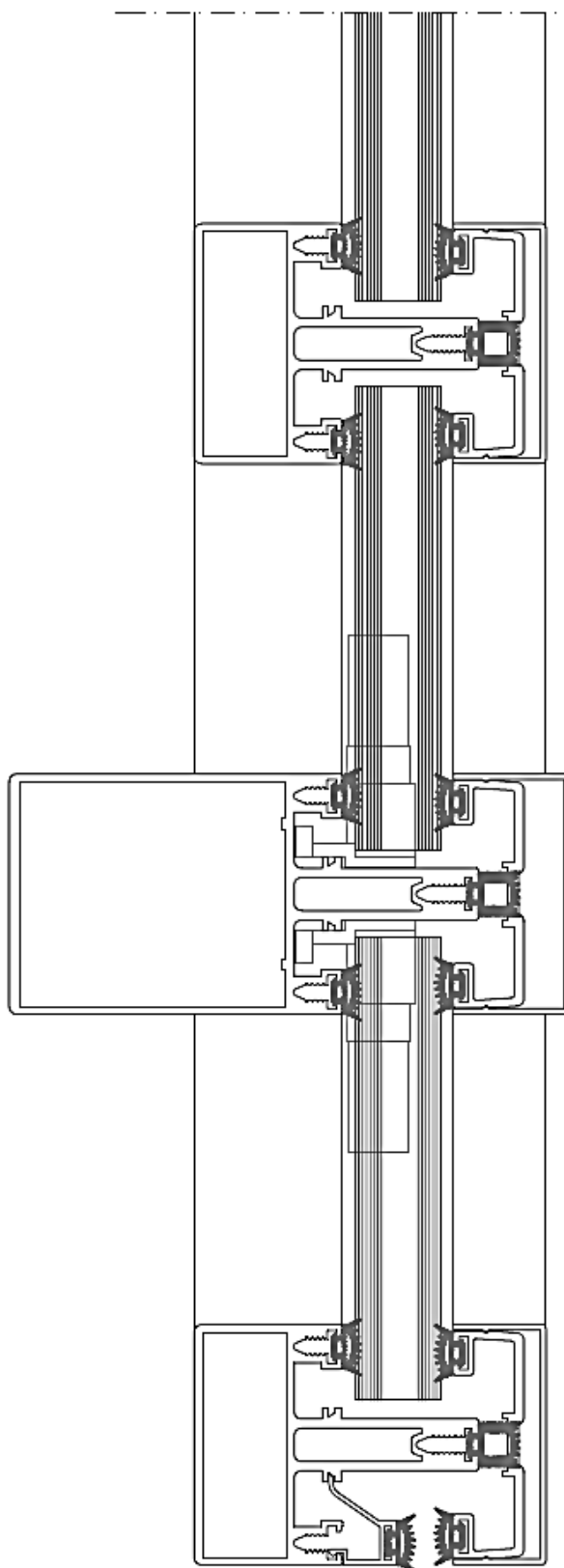

MONTAGEM DO CANTO DE FACHADAS

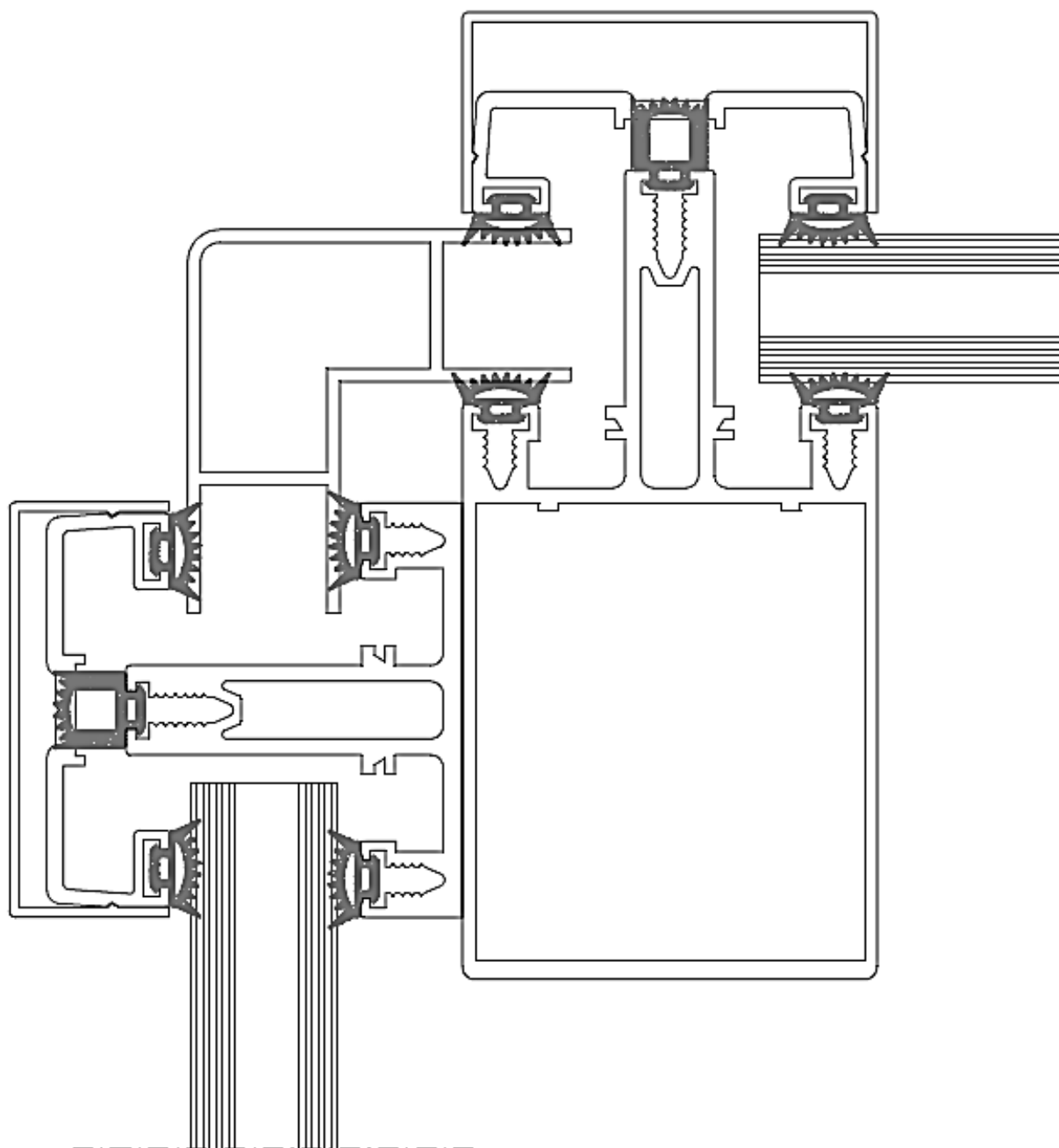

MONTAGEM DA FACHADA C/ FIXAÇÃO DOS PRUMOS

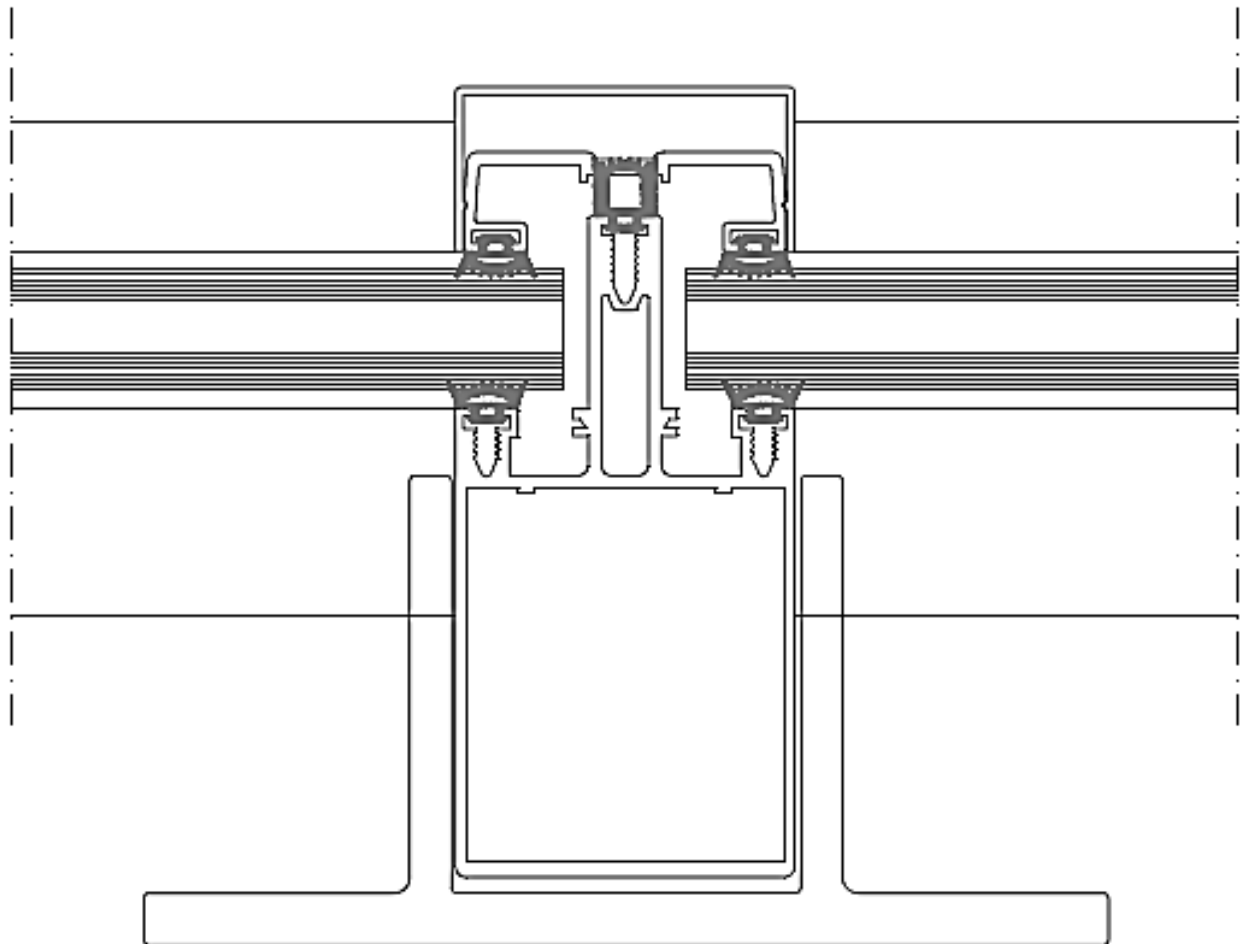



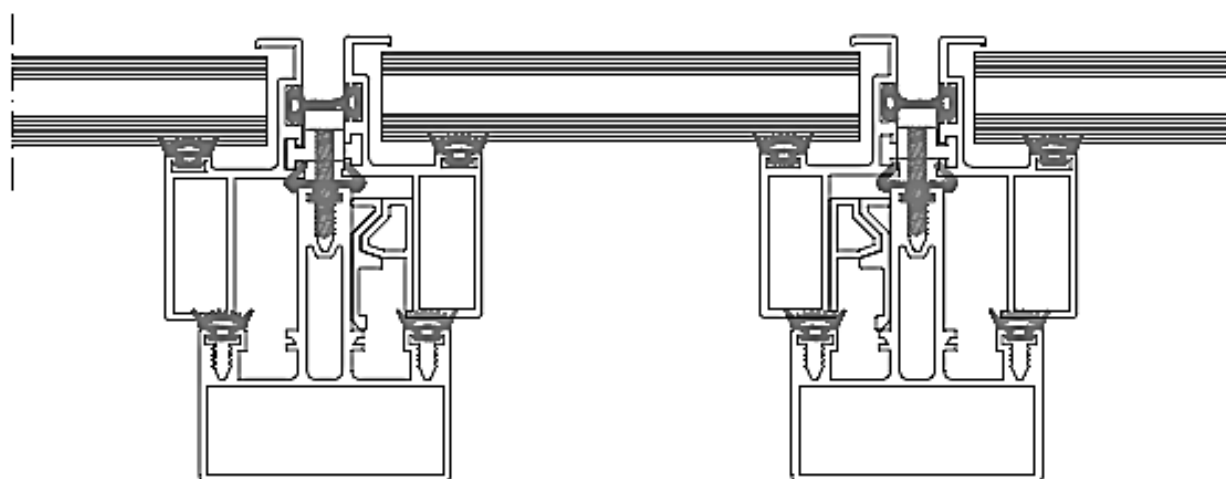
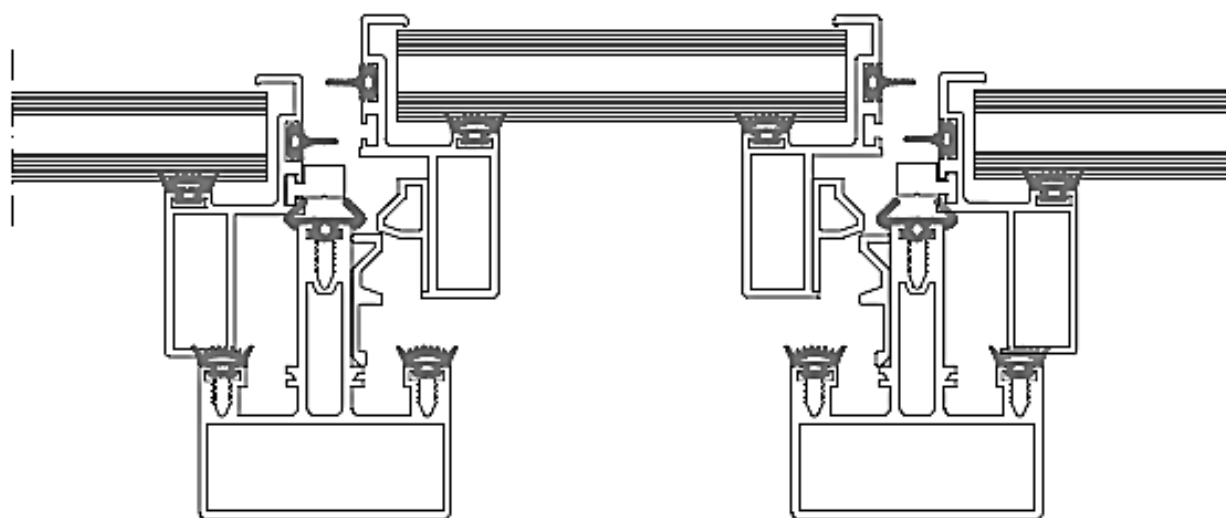



MONTAGEM DE FACHADA SEMI-ESTRUTURAL C/ PERFIS DE FIXAÇÃO

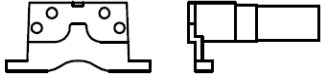

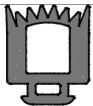

ACESSÓRIOS

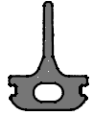
| Ilustração | N/ Referência | Designação |
|---|-----------------|--|
|  | FIXA TFA | Peça p/ Fixação das Travessas |
|  | ----- | Peça de Fixação da Fachada Semi-Estrutural |
|  | ----- | Peça de Fixação da Fachada |
|  | VD TFA | Borracha de Encosto da Travessa |
|  | PER 4006 | Borracha 8mm |
|  | PER 4003 | Borracha 3mm |
|  | ----- | Borracha Central Semi-Estrutural |
|  | ----- | Vedante Semi-Estrutural |