











PERFIS DE COMPLEMENTO

Séries Diversas



LISTA DE PERFIS

Perfil	Designação	Referência	Perfil	Designação	Referência
	Perfil de complemento	TS 2010		Montante	TS 2018
	Montante	TS 2012		Perfil de complemento	TS 2040
	Calha dupla	TS 2013		Pingadeira	TS 4003
	Calha para pelúcia	TS 2014		Perfil ligação de prumos	TS 4004
	Tubo triangular	TS 2015		Aro para porta de correr	TS 4010
	Montante	TS 2017			



PERFIS DE COMPLEMENTO



TS 2010

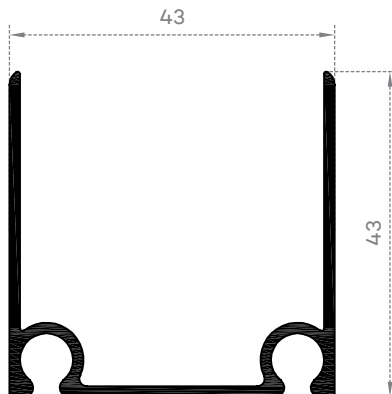

TS 2040



MONTANTES

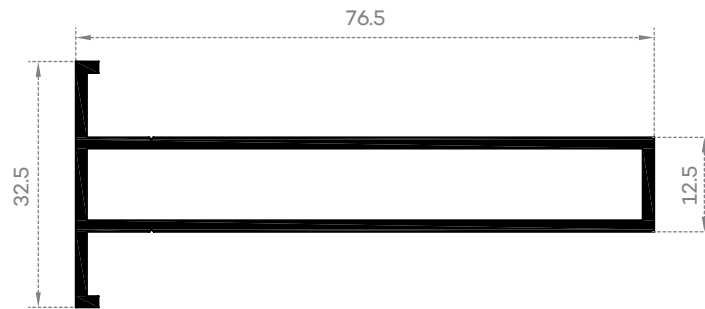

TS 2012

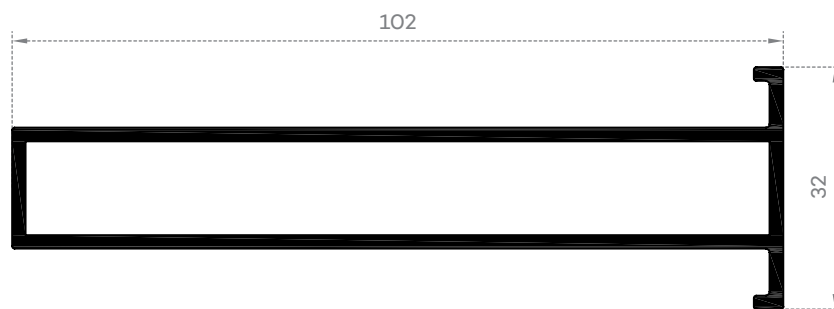

TS 2017

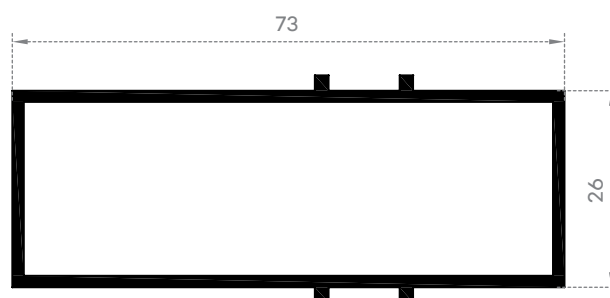

TS 2018



CALHAS

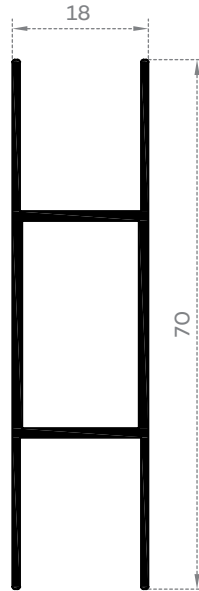

TS 2013

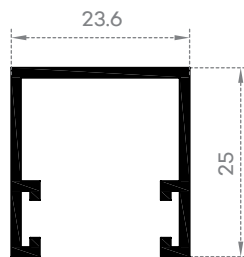

TS 2014



TUBO TRIANGULAR

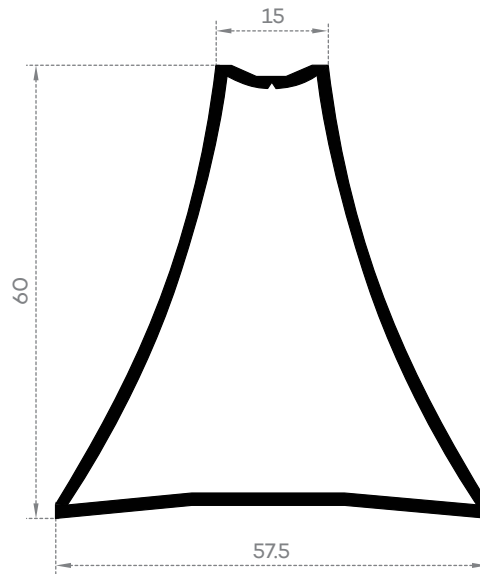

TS 2015

PINGADEIRA

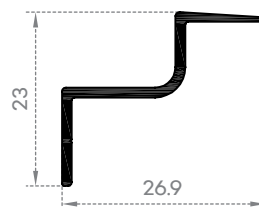

TS 4003



ARO PARA PORTA DE CORRER

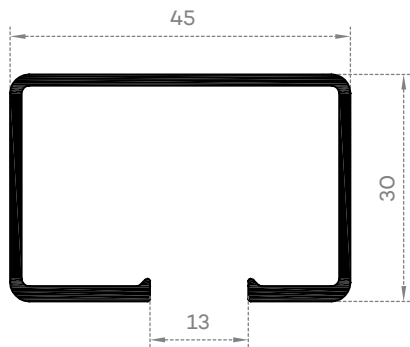

TS 4010

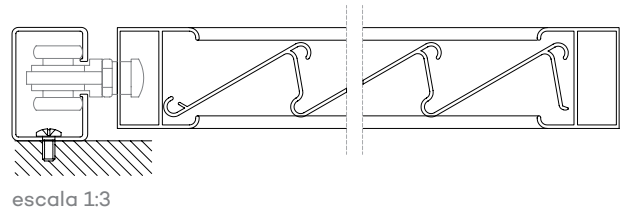

PERFIL LIGAÇÃO DE PRUMOS

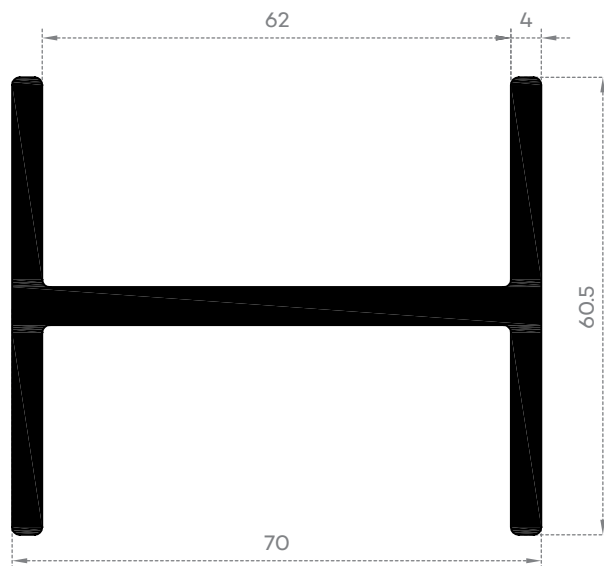

TS 4004