

# TPT

Série Robusta para  
Portões de Soldar





# LISTA DE PERFIS

Perfil	Designação	Referência	Perfil	Designação	Referência
	Prumo	TPT 01		Prumo	PER 4042
	Prumo	TPT 02		Perfil para receber prumo	N 31357
	Travessa	PER 2563		Perfil para receber prumo	APT 010
	Aro móvel grande	PER 4037		Perfil para receber prumo	APT 011
	Aro móvel pequeno	PER 4038			



# PRUMOS

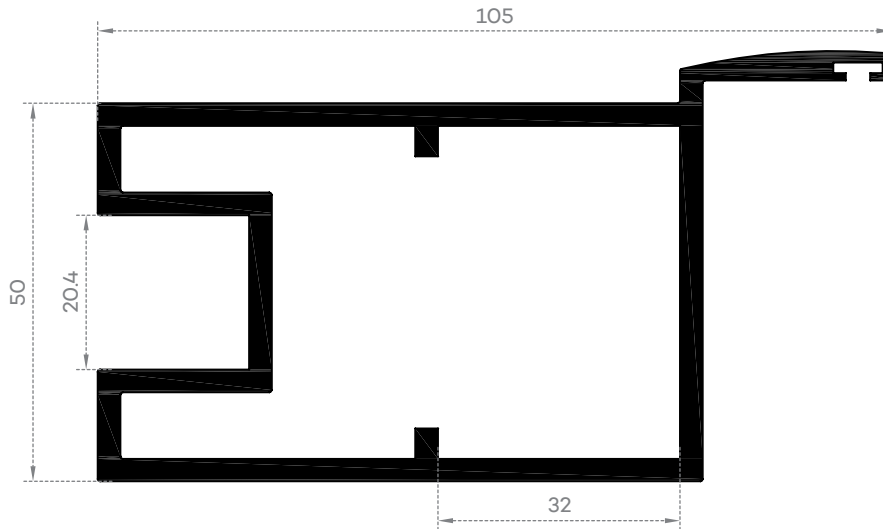

TPT 01

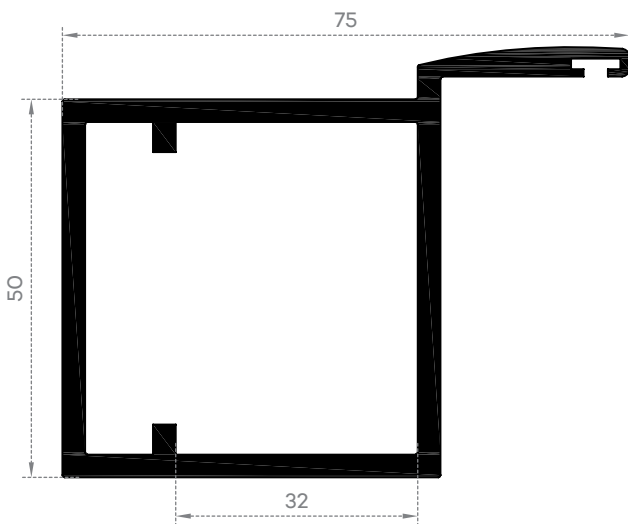

TPT 02

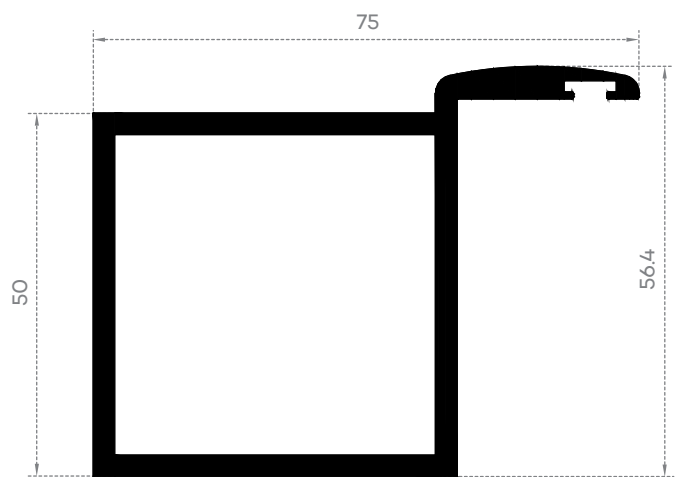

PER 4042



# TRAVESSA

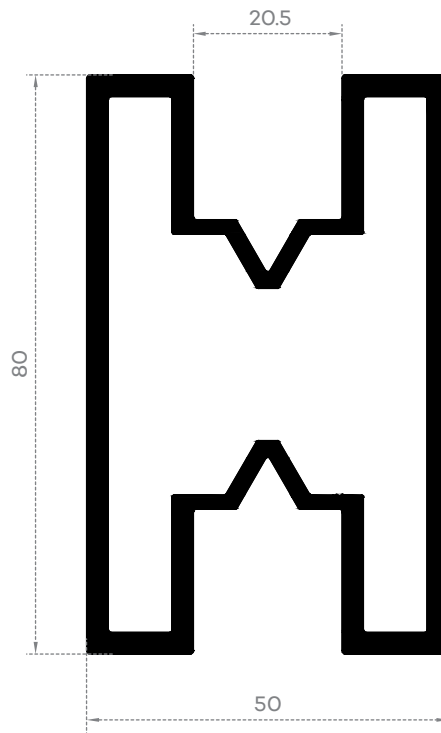

PER 2563



# AROS MÓVEIS

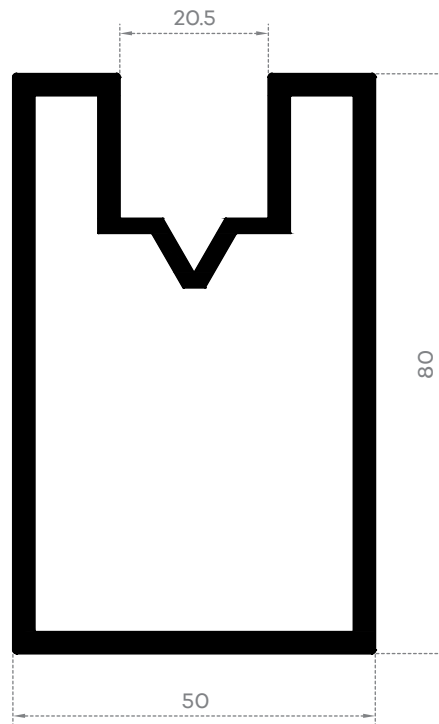

PER 4037

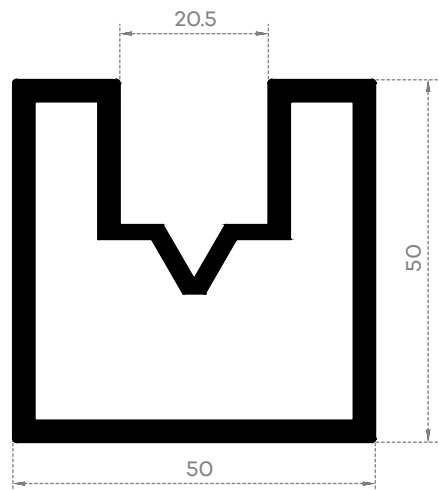

PER 4038



# PERFIS PARA RECEBER PRUMO

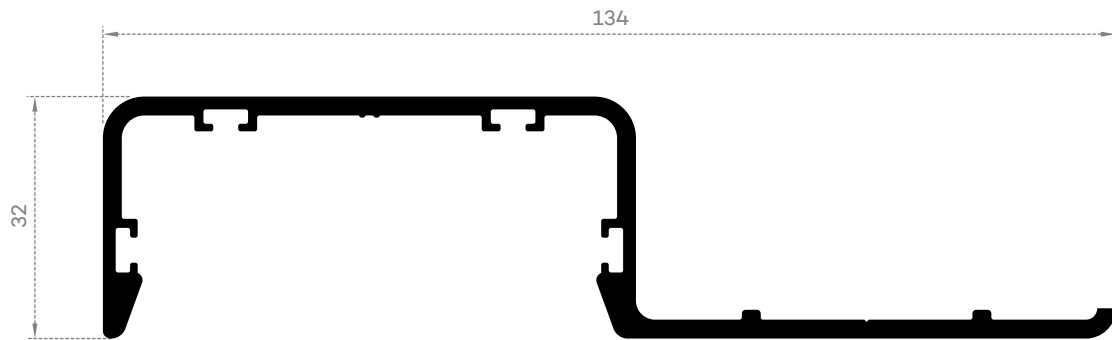

N 31357

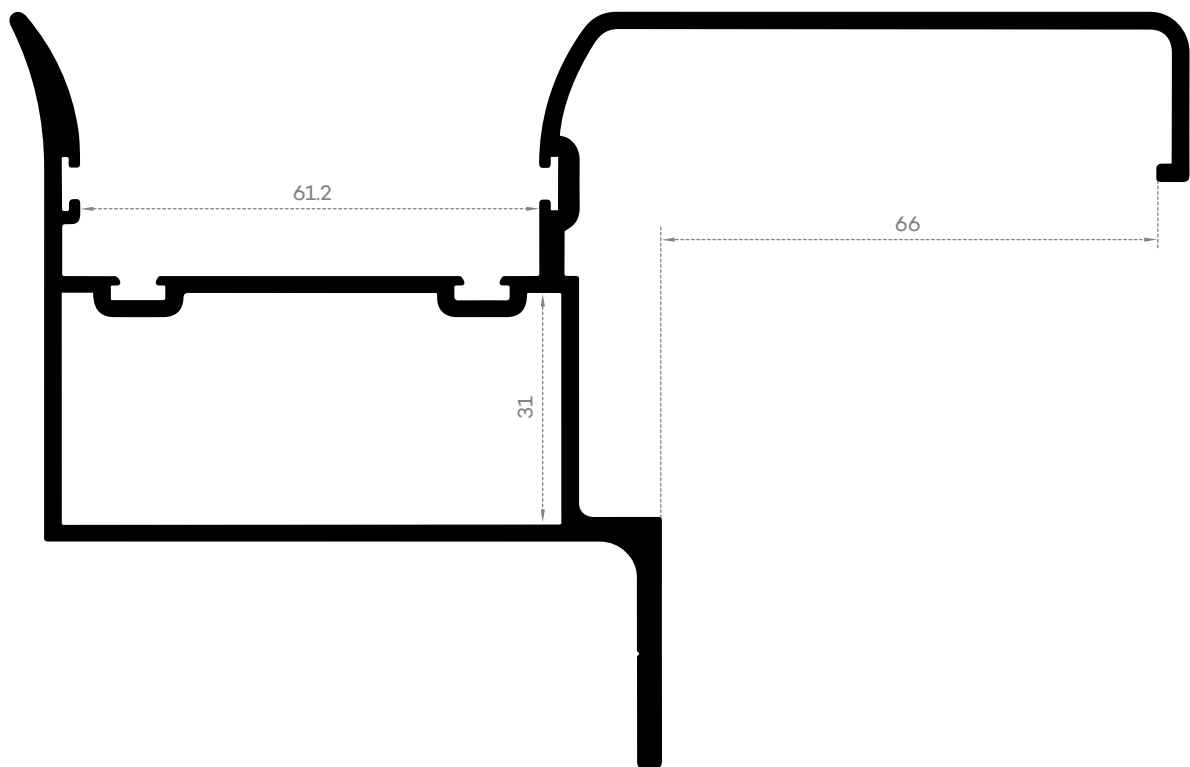

APT 010

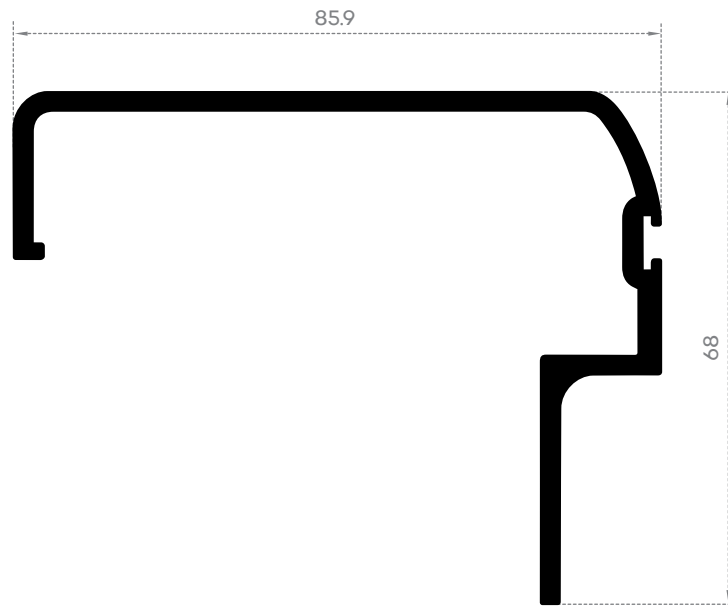

APT 011

## LÂMINA PARA PORTÕES

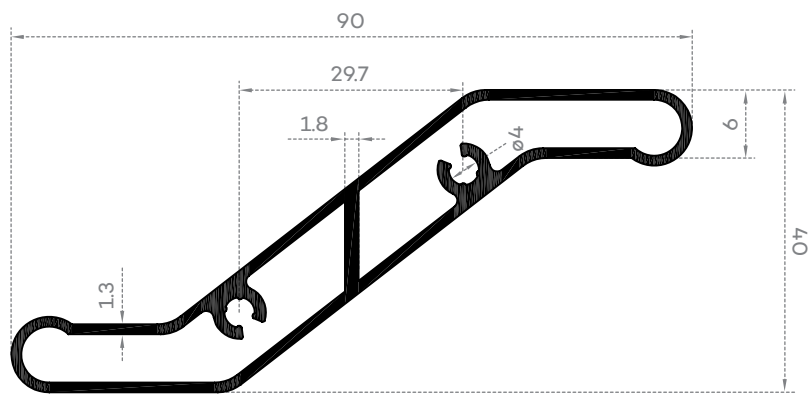

TS 2090







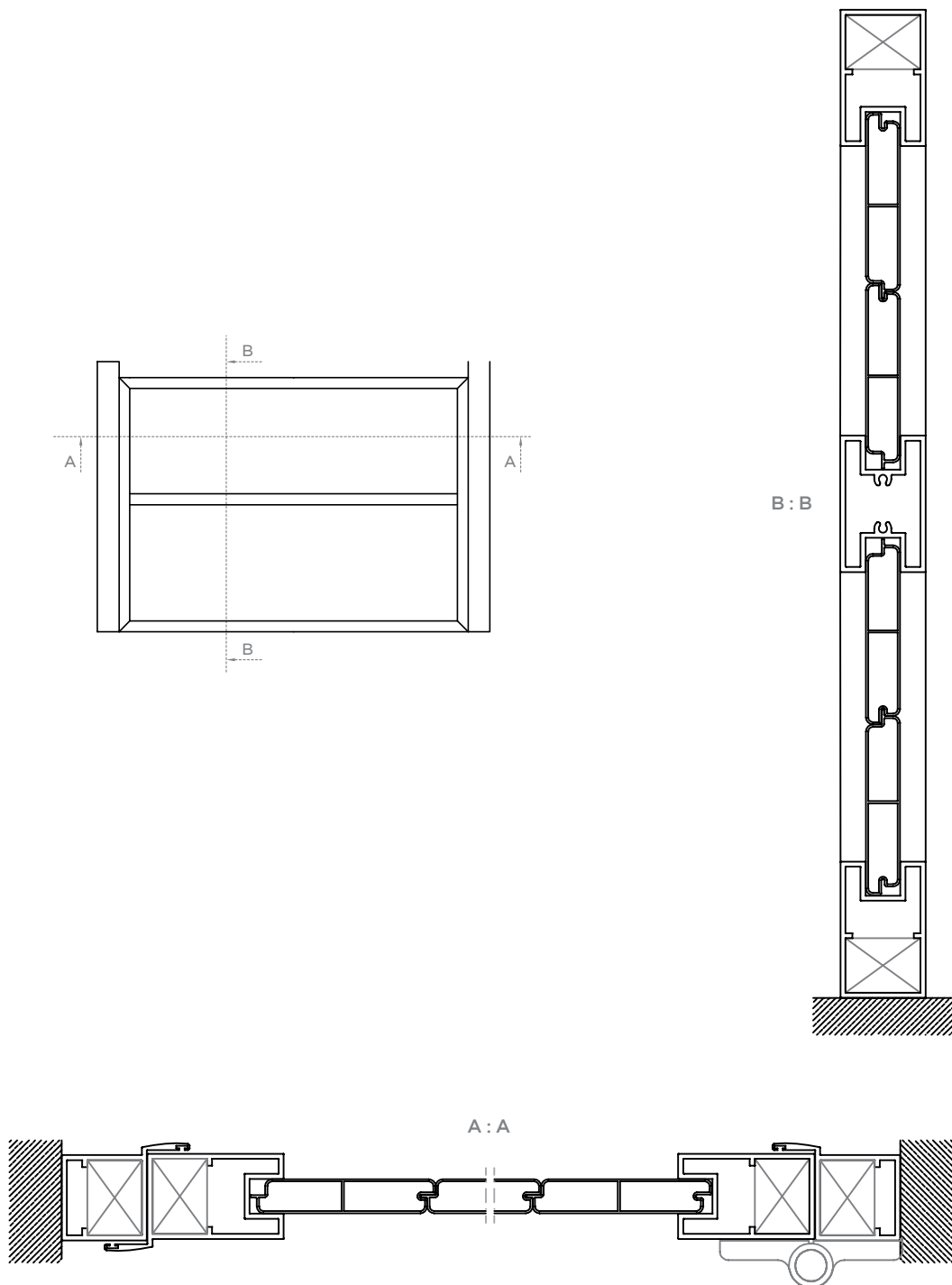

# PORTÃO DE 1 FOLHA COM ABERTURA PARA O INTERIOR





## LISTA DE ACESSÓRIOS

Representação	Designação	Referência	Tratamento	Material
	Dobradiça dupla (para soldar)	DOBTPT1	...	...
	Dobradiça tripla (para soldar)	DOBTPT2	...	...
	Dobradiça dupla (para aparafusar)	DOBPORTAOD	Bruto	Alumínio Eixo inox
	Dobradiça tripla (para aparafusar)	DOBPORTAOT	Bruto	Alumínio Eixo inox
	Roldanas em inox (para calha cantoneira)	CETPT	...	...
	Fechadura elétrica para portão	FECHPORTAO	...	...
	Esquadro para prumo	TA1026	...	...